

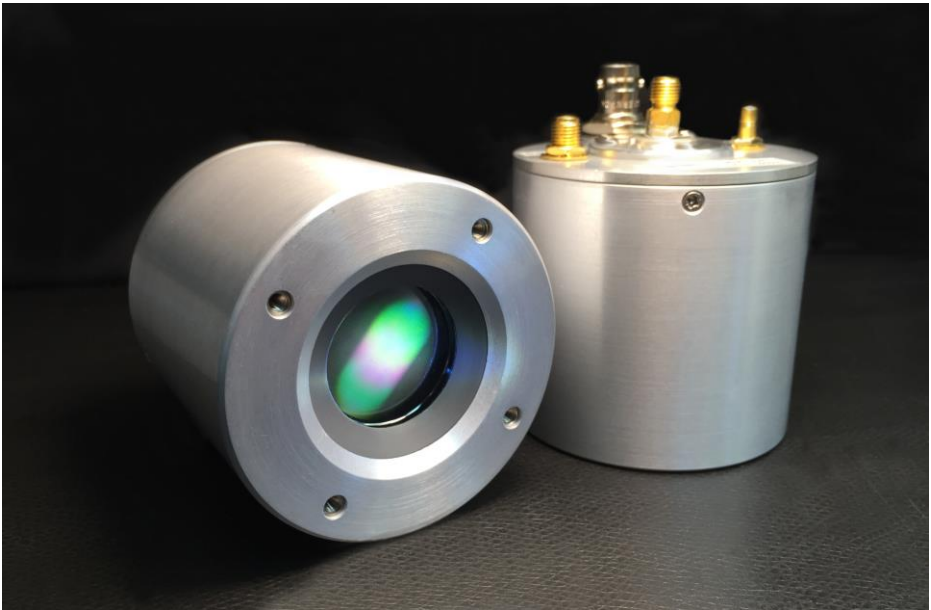

Photomultiplier & Photodiode User Guide



This User Manual is intended to provide guidelines for the safe operation of Photek PMT Photomultiplier Tubes and Photodiodes.

Please contact Sales or visit: www.photek.co.uk for further information

Notes:

Contents

Health and Safety Advice.....	4
<i>High Voltage.....</i>	<i>4</i>
<i>X-Ray Radiation.....</i>	<i>4</i>
Storage and Handling	4
Operation with an External PSU	5
Photomultiplier Tube	6
<i>Structure of MCP Photomultipliers:.....</i>	<i>6</i>
Mode of Operation.....	7
Photodiode.....	7
<i>Structure of Photodiodes:.....</i>	<i>7</i>
Input Windows.....	8
Photocathode Spectral Sensitivities	8
Photocathodes on Quartz (Fused Silica)	9
MCP Stack Configurations (PMTs only).....	10
Internal Dropper Network:.....	12
PMT Characteristics:.....	13
<i>Gain (Not applicable to Photodiodes)</i>	<i>13</i>
<i>Timing:</i>	<i>14</i>
<i>Rise/Fall time:.....</i>	<i>14</i>

Gating.....	16
<i>Gating Procedure:</i>	<i>17</i>
Gate Units	21
Configuration Diagram and setup:.....	22
Illumination Levels	23
Saturation characteristics:.....	23
Glossary of terms	24
<i>Electron Gain</i>	<i>24</i>
<i>Photocathode</i>	<i>24</i>
<i>Quantum Efficiency</i>	<i>24</i>
<i>Radiant Sensitivity.....</i>	<i>25</i>
<i>Spectral Response</i>	<i>25</i>

Health and Safety Advice

High Voltage

High voltage devices can be hazardous if they are not installed, operated and maintained correctly, or if a device is damaged. Photek cannot accept responsibility for damage or injury resulting from the use of Photek devices. Equipment manufacturers and users should ensure appropriate precautions are taken. Warning labels and notices must be provided on equipment and in operating manuals.

High Voltage Equipment must be designed so that operators cannot come into contact with high voltage circuits. Tube enclosures should have fail-safe interlocked switches to disconnect the primary power supply and discharge all high voltage capacitors before allowing access.

X-Ray Radiation

All high voltage devices produce X-rays during operation and may require shielding.

Storage and Handling

Avoid storage or operation of Photomultipliers (PMTs) or Photodiodes (PDs) at temperatures greater than +40°C. Room temperature is preferred (21°C). Keep the cathode covered or in the dark when not in use as this minimises dark noise generated by fluorescence. Protect the cathode from intense focused light, sunlight and lasers, even when not running, as this can lead to local thermal overloads and cathode damage.

Avoid excessive shock or vibration to the detector as this could damage delicate internal components, such as the Microchannel Plate (MCP). Keep the cathode optic free of dirt or grease as this can be detrimental to optimum performance.

Avoid running the PMT or PD for long periods of time with a bright focussed image as this can cause localised damage to the cathode or MCPs.

Operation with an External PSU

If the Photomultiplier or Photodiode is to be powered by the customer's own power supply, it is important to gradually increase the applied voltage to the required level. It is equally important to gradually reduce and monitor voltages when powering off the PMT or PD.

IMPORTANT:

The maximum operating voltage is recorded in the Test Data Summary and labelled on the device and must **NEVER** be exceeded.

Separate low voltage PSUs may be required if the PMT or PD is operated in conjunction with devices such as Gate units or Pre-amplifiers etc. Photek digital PSUs include peripheral outputs to be used with these assorted electronics.

Customers using their own power supplies should discuss the suitability of the power supply with Photek Ltd to ensure that it is compatible with the PMT or PD being operated, particularly with respect to electrical insulation, encapsulation and earthing.

Photomultiplier Tube

A PMT consists of three basic elements:

An input window capable of transmitting light over a particular spectral range that can span from the near UV to near IR with a photocathode deposited on its inner surface.

One or more MCPs to provide electron gain.

An output Anode where the secondary emitted electrons from the MCPs are collected and converted to a proportional o/p current.

Structure of MCP Photomultipliers:

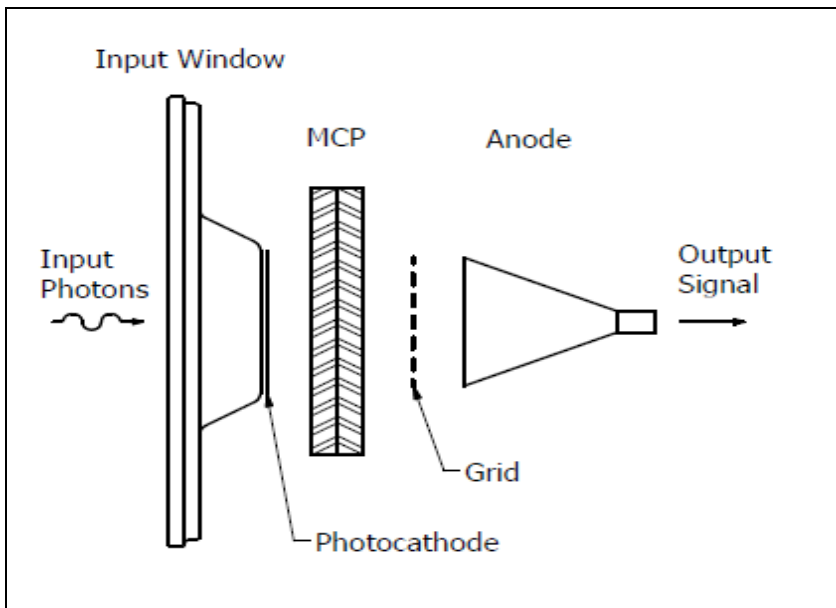

Mode of Operation

When photons are focused onto the photocathode, electrons are emitted in proportion to the intensity of the incoming photons. The electron cloud is then focused onto the MCP, which amplifies the electrons before being accelerated onto the anode, where a proportional electrical current is reproduced.

Photodiode

A photodiode follows a similar design and construction to the Photomultiplier, but without the MCP.

The Photodiode differs from the Photomultiplier in that it has no electron gain and cannot be gated in the conventional manner that a PMT is gated. Gating requires the use of a special gating PSU.

Structure of Photodiodes:

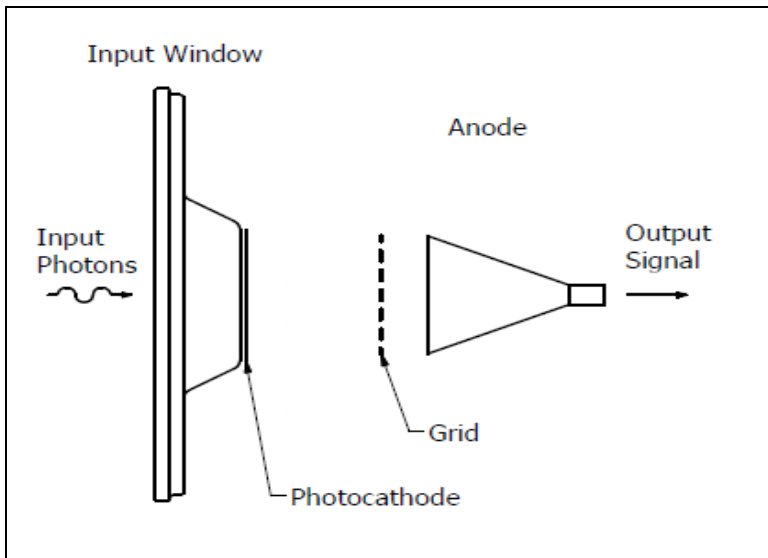

Input Windows

Photek can supply PMTs or PDs with the following input windows:

-Fused Silica

-MgF₂

-Sapphire

Other input windows available on request.

Photocathode Spectral Sensitivities

The spectral range of the photocathode depends on the type of input window used. Fused Silica, Magnesium Fluoride or Sapphire input windows will extend the spectral range to the limit imposed by the transmission of these materials (180 nm for Fused Silica, 150 nm for Sapphire and 110 nm for MgF₂).

Photocathodes on Quartz (Fused Silica)

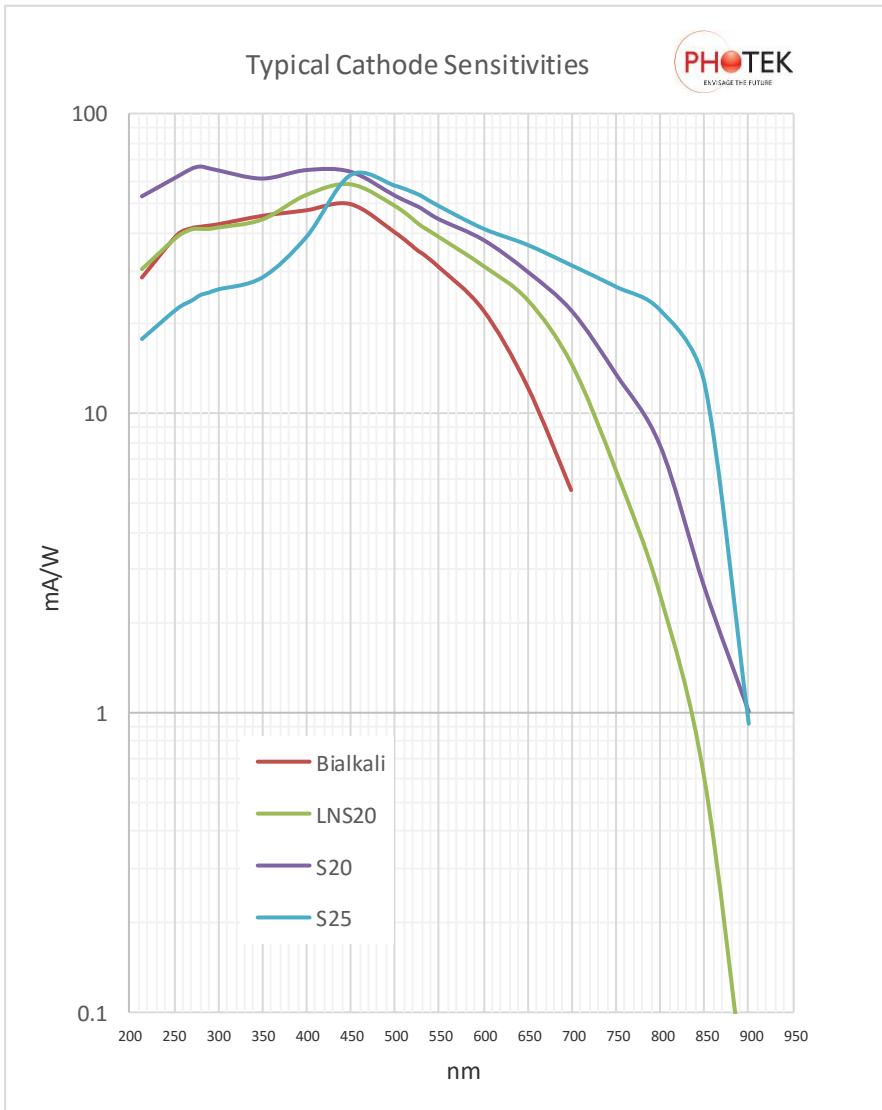

MCP Stack Configurations (PMTs only)

Microchannel plates are typically configured in single, chevron or Z stacks with the latter two being used in PMT2xx and PMT3xx Photomultipliers.

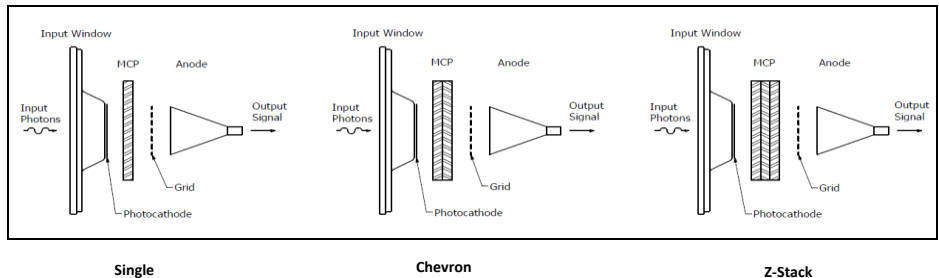

The bias angle is rotated by 180 degrees as each plate is added to the stack, resulting in the chevron and Z stacks. These stacks reduce the chance of ion feedback from the channel plates to the photocathode and it enhances secondary emission at the front of the second and third MCPs. This can result in improved PHD characteristics.

With a single MCP, there is a physical limitation in gain of about 10^4 . With gain values above 10^4 , ion feedback can occur as the electron shower becomes more intense and this can reduce the life of the PMT. By stacking 2 or 3 plates in chevron or Z stack configuration, ions generated in the 2nd or 3rd MCP cannot travel back to the photocathode as they are blocked in the interface between the two MCPs.

High gain can be obtained by using a 2 stage PMT (10^6) or 3 stage PMT (10^7), thus enabling use in photon counting applications.

Photek PMTs are available in a range of different MCP configurations. These include the stack configuration, l/d ratio and the pore/pitch ratio of the microchannel plate.

The table below shows typical configurations.

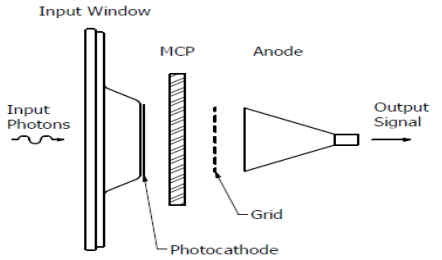
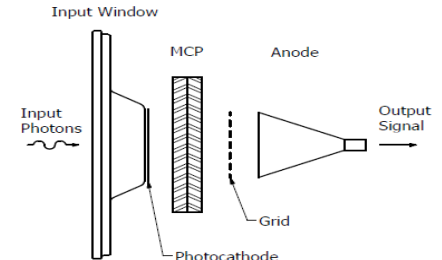
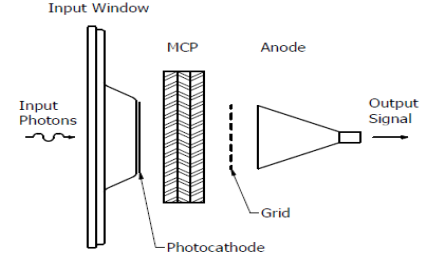
<p>PMT1xx Single plate PMT Typical MCP Configuration:</p> <table border="1" data-bbox="96 432 553 571"> <thead> <tr> <th><i>l/d ratio</i></th> <th><i>diameter/pitch (μm)</i></th> <th><i>Anode Diameter</i></th> <th><i>Thickness</i></th> </tr> </thead> <tbody> <tr> <td>59:1</td> <td>3.4/4</td> <td>10mm</td> <td>0.20mm</td> </tr> <tr> <td>43:1</td> <td>10/12</td> <td>25mm</td> <td>0.43mm</td> </tr> <tr> <td>46:1</td> <td>10/12</td> <td>40mm</td> <td>0.46mm</td> </tr> </tbody> </table>	<i>l/d ratio</i>	<i>diameter/pitch (μm)</i>	<i>Anode Diameter</i>	<i>Thickness</i>	59:1	3.4/4	10mm	0.20mm	43:1	10/12	25mm	0.43mm	46:1	10/12	40mm	0.46mm	
<i>l/d ratio</i>	<i>diameter/pitch (μm)</i>	<i>Anode Diameter</i>	<i>Thickness</i>														
59:1	3.4/4	10mm	0.20mm														
43:1	10/12	25mm	0.43mm														
46:1	10/12	40mm	0.46mm														
<p>PMT2xx Typical MCP Configuration:</p> <table border="1" data-bbox="96 756 553 895"> <thead> <tr> <th><i>l/d ratio</i></th> <th><i>diameter/pitch (μm)</i></th> <th><i>Anode Diameter</i></th> <th><i>Thickness</i></th> </tr> </thead> <tbody> <tr> <td>59:1</td> <td>3.4/4</td> <td>10mm</td> <td>0.22mm</td> </tr> <tr> <td>43:1</td> <td>10/12</td> <td>25mm</td> <td>0.43mm</td> </tr> <tr> <td>46:1</td> <td>10/12</td> <td>40mm</td> <td>0.46mm</td> </tr> </tbody> </table>	<i>l/d ratio</i>	<i>diameter/pitch (μm)</i>	<i>Anode Diameter</i>	<i>Thickness</i>	59:1	3.4/4	10mm	0.22mm	43:1	10/12	25mm	0.43mm	46:1	10/12	40mm	0.46mm	
<i>l/d ratio</i>	<i>diameter/pitch (μm)</i>	<i>Anode Diameter</i>	<i>Thickness</i>														
59:1	3.4/4	10mm	0.22mm														
43:1	10/12	25mm	0.43mm														
46:1	10/12	40mm	0.46mm														
<p>PMT3xx Typical MCP Configuration:</p> <table border="1" data-bbox="96 1066 553 1204"> <thead> <tr> <th><i>l/d ratio</i></th> <th><i>diameter/pitch (μm)</i></th> <th><i>Anode Diameter</i></th> <th><i>Thickness</i></th> </tr> </thead> <tbody> <tr> <td>59:1</td> <td>3.4/4</td> <td>10mm</td> <td>0.22mm</td> </tr> <tr> <td>43:1</td> <td>10/12</td> <td>18mm</td> <td>0.43mm</td> </tr> <tr> <td>43:1</td> <td>10/12</td> <td>25mm</td> <td>0.43mm</td> </tr> </tbody> </table>	<i>l/d ratio</i>	<i>diameter/pitch (μm)</i>	<i>Anode Diameter</i>	<i>Thickness</i>	59:1	3.4/4	10mm	0.22mm	43:1	10/12	18mm	0.43mm	43:1	10/12	25mm	0.43mm	
<i>l/d ratio</i>	<i>diameter/pitch (μm)</i>	<i>Anode Diameter</i>	<i>Thickness</i>														
59:1	3.4/4	10mm	0.22mm														
43:1	10/12	18mm	0.43mm														
43:1	10/12	25mm	0.43mm														

Internal Dropper Network:

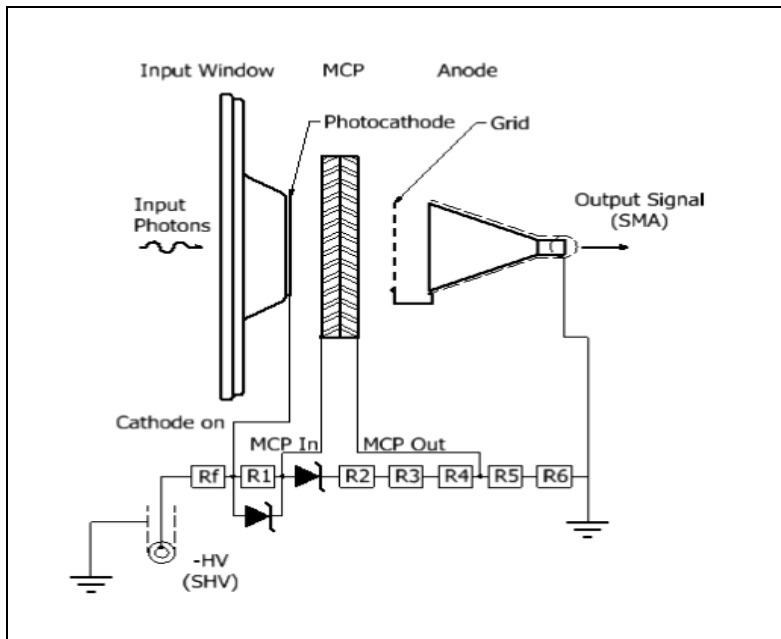

The PMT operates by applying the correct voltage to each electrode. A voltage divider network is used which splits the voltages according to the resistor values used in the circuit. The figure above details a two stage PMT network.

A negative high voltage is applied to the photocathode and the voltage divider circuit applies a high voltage gradient across MCP in, MCP out and Grid by dividing the voltages across the electrodes according to resistor values. The high voltage circuit and the PMT housing are carefully designed to prevent any distortion in the output signal which is usually caused by “ringing” due to high frequency signals.

A Photodiode does not need an internal dropper network and simply connects the high voltage supply to the photocathode.

Note: The PMT or PD should NEVER be powered up without suitably terminating the output signal connector (SMA/N-type). It is also worth noting that as the inner anode is floating and is susceptible to a very high static charge build up. The PMT must never be operated with the output connector open circuit.

PMT Characteristics:

Gain (Not applicable to Photodiodes)

The gain of the PMT depends on the number of MCPs incorporated in the PMT. The gain is determined by the length to diameter ratio (L/d) of a channel.

The graphs below show Gain versus Supply voltage characteristics.

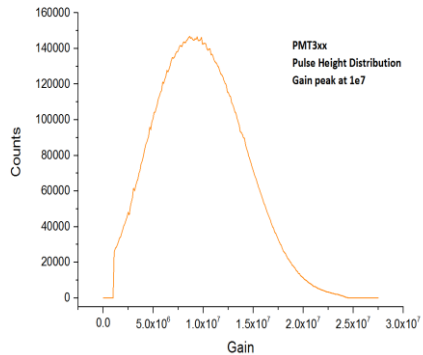
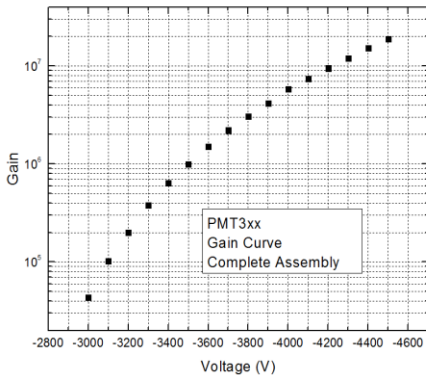
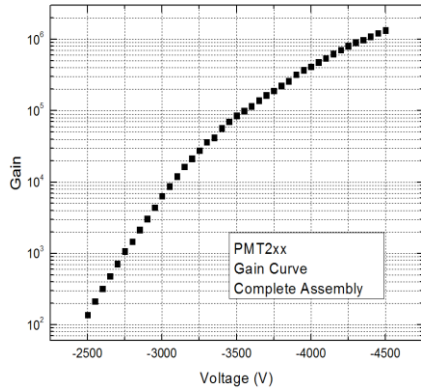
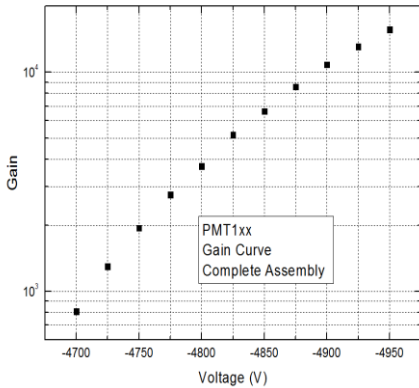

Timing:

Time response characteristics are very important when choosing a PMT or PD for a particular application. As a very strong voltage gradient is applied between Photocathode to 'MCP in' and the 'MCP out' to anode, (or between cathode and anode in a PD), the electron transit time in the secondary multiplication process is significantly fast. By using the MCPs as the secondary electron emission medium, the time response of the PMTs can be as fast as 100ps FWHM. This enables PMTs and PDs to be used to observe and measure ultra-fast optical pulses.

Rise/Fall time:

Rise and fall times are evaluated by using a fast laser pulse generator that has a short pulse width (45ps) compared to the time response of a PMT. These measurements are critical in establishing ultra-fast optical pulses with very high precision.

The figures below and on page 15 show the time response of various Photek PMTs and PDs.

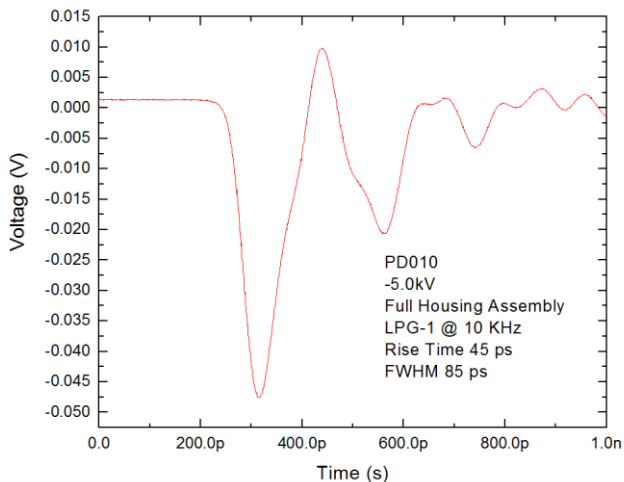

Rise/Fall times continued:-

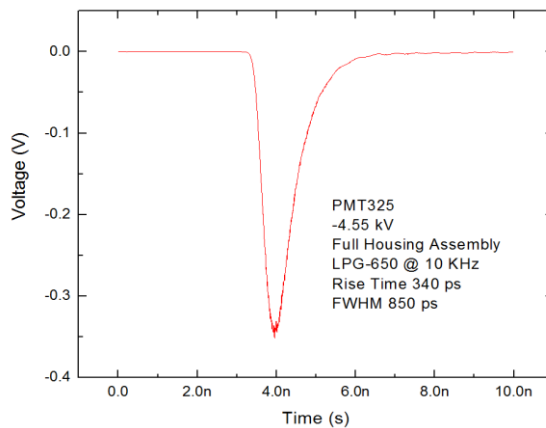
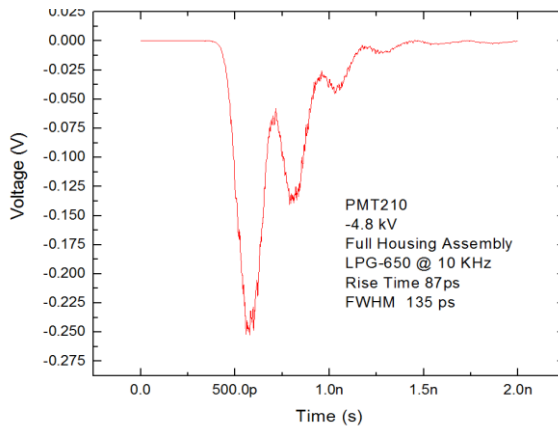
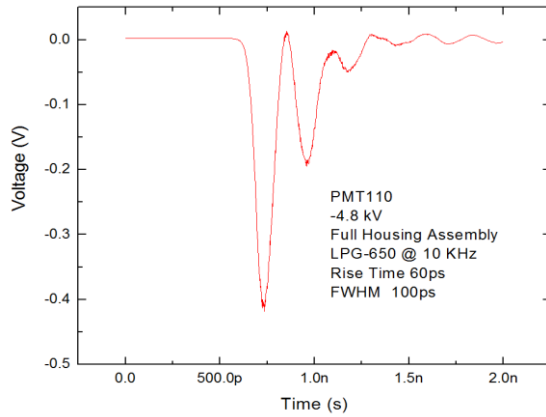

Rise Time (ps)

MCPs	Detector Active Diameter											
	10 mm			18 mm			25 mm			40 mm		
	Min.	Typ.	Max.	Min.	Typ.	Max.	Min.	Typ.	Max.	Min.	Typ.	Max.
0		50			*		60	80	100	60	80	100
1	60	65	70		*			115		100	150	200
2	75	85	95		*			190		180	230	280
3		105			250		300	400	500		350	

FWHM (ps)

MCPs	Detector Active Diameter											
	10 mm			18 mm			25 mm			40 mm		
	Min.	Typ.	Max.	Min.	Typ.	Max.	Min.	Typ.	Max.	Min.	Typ.	Max.
0		80			*		100	150	200	100	150	200
1	100	110	120		*			700		300	450	600
2	130	150	170		*			840		600	850	1100
3		170			400		800	1000	1200		1200	

Gating

This section relates to the gating of PMTs, but if gating is required on a PD, this could be achieved by gating the high voltage PSU. Please contact Sales for further details.

Most PMTs have gating capabilities, allowing the device to be used as a fast optical switch or shutter. The gating speed is proportional to the RC time constant of the gap between the photocathode and MCP, where R is the resistance of the photocathode and C is the capacitance of the gap between the photocathode and MCP.

Photocathodes generally have a relatively high resistance. Multi-alkali photocathodes generally have a lower resistance than Bialkali or Solar Blind cathodes. For gating applications, it is necessary to reduce the photocathode resistance and this can be done by applying an underlay or mesh to the input window prior to deposition of the Photocathode.

Underlays are typically evaporated transparent conducting layers directly applied to the cathode substrate. Depending on the gating characteristics required, the transmission of the layer will be in the range 50 % to 98 %. A 50 % transmission underlay should allow gating to 5 ns on a 25 mm PMT, whereas a 95 % transmission underlay may only achieve 100 ns gating. The disadvantage of thick underlays is that the spectral sensitivity can be significantly reduced depending upon the wavelength of interest.

For faster gating performance or where loss of spectral sensitivity cannot be tolerated, a mesh can be photo-etched onto the input window.

The capacitance is proportional to the surface area of the cathode and inversely proportional to the gap between cathode and MCP. Smaller area PMTs and PMTs with a large cathode to MCP gap will gate faster. The table below outlines typical cathode capacitance and is for guidance only:

Active Diameter (mm)	Cathode to MCP Gap (μm)	Ceramic Capacitance (pF)	Gap Capacitance (pF)	Total Capacitance (pF)
40	200	38	58	96
40	100	38	117	155
40	50	38	234	272
25	200	16	23	39
25	100	16	47	63
25	50	16	94	110
18	200	8	13	21
18	100	8	26	34
18	50	8	52	60

Gating Procedure:

Photek PMTs have the capability to be gated ON or OFF with transition times as short as 3 ns and an extinction ratio (the ratio of ON to OFF sensitivity) as high as 10^{13} . Due to the operational nature of the PMT the gate pulse has to be A.C. coupled, and this means that to avoid a significant baseline shift the duty cycle of the gate pulse has to be limited to 10% or less. The design of the Photek PMT allows the user to choose the gating mode between being “normally ON” and gated OFF for a short period (<10% of the repetition period), or being “normally OFF” and gated ON for a short period (<10% of the repetition period). This procedure will describe the correct triggering method for the various Photek gate modules in each mode.

Please note: If the gate unit is operating in normally OFF mode and the PMT is operating normally ON (or vice versa), this could result in damage to both gate unit and the PMT. Similarly, if the duty cycle exceeds 10% in either mode damage may occur.

Photek gate units all work in a similar manner. They take a TTL logic level input and generate a corresponding high voltage output between +50 V (OFF) and -200 V (ON). Most of the gate units are “inverting” modules, such that a low logic level input produces a +50 V output and a high logic level input produces a -200 V output, with the exception of the GM300-3P which is a “non-inverting” module and operates with the opposite polarity.

Although it was designed specifically for normally ON operation, the GM300-3P can work in normally OFF mode down to a minimum gate pulse width of 50 ns. Similarly, the GM300-3N can work in normally ON mode down to a minimum gate pulse width of 50 ns. The GM300-8U and the GM10-50B are “universal” gate units in that they can operate fully in either normally ON or normally OFF mode simply by changing the polarity of the trigger input.

The gating mode of normally ON or normally OFF is defined by the voltage at the input to the SMB connector. By default, (i.e. with nothing connected or 0 V applied) the PMT will be normally ON. If a D.C. voltage is applied to the SMB connector, which can be anything between +5 V and +30 V, the PMT will be normally OFF. If the PMT needs to be operated in normally OFF mode, the most convenient method would be to use an SMB T-piece and a short length of SMB cable to take the +5 V or +12 V power supply for the gate unit and plug this into the PMT. On request Photek can supply a PMT to be hard-wired normally OFF so that no low voltage supply is needed, but please note that with this option the PMT will be unable to operate in a constantly ON condition.

When gating a PMT, the logic polarity of the trigger signal to the gate unit needs to be properly matched to the chosen gating mode and this is detailed in the diagrams below:

The figure on page 19 shows the gating of a PMT110 in N-ON mode as seen in infinite persistence mode. A small ‘OFF’ time window has been set where the cathode will have a reverse bias which helps the photocathode to be opaque to any optical pulses in that time window. This type of gating is particularly useful when a PMT is used to detect a very tiny optical event and gate off a large event that can saturate the PMT. This helps the PMT to act as a very fast optical shutter to mask off any unwanted signals. Similarly, N-OFF mode can also be carried out where the PMT can be turned ‘ON’ for a very small time period and is turned off for the rest. The duty cycle for either turn ON or turn OFF times cannot exceed 10%.

Normally ON

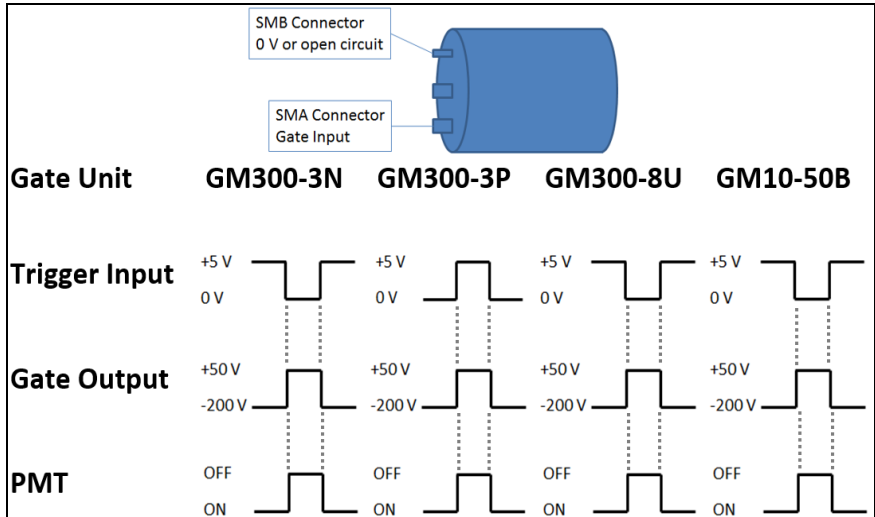

Gating parameters to be set for normally ON gating

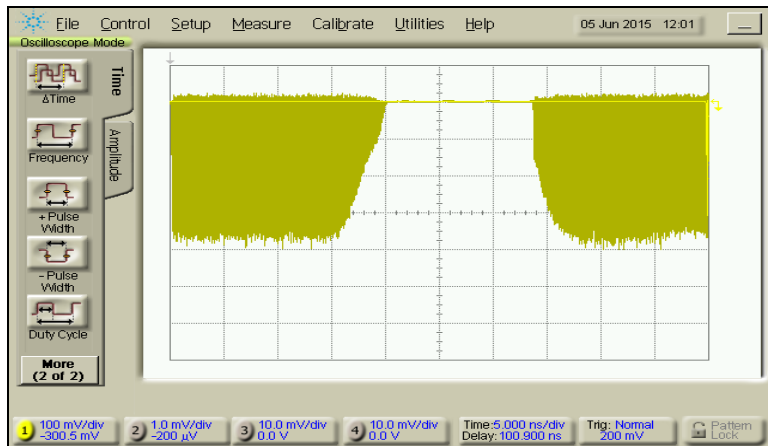

Normally ON gating mode

The figure above shows the gating transition of a PMT in normally ON mode with ON-OFF & OFF-ON transition in less than 5ns with a gate OFF width of 30ns. The green shaded portion of the graph depicts signal.

Normally OFF

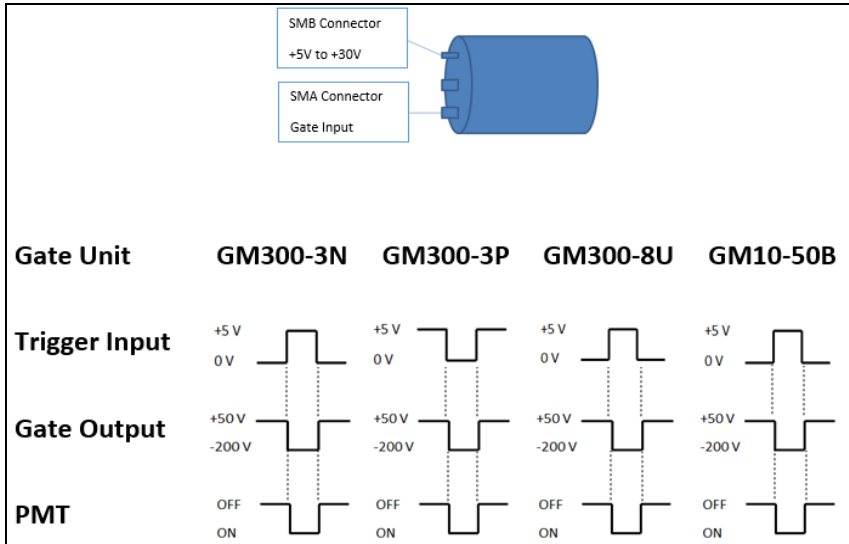

Gating parameters to be set for normally OFF gating

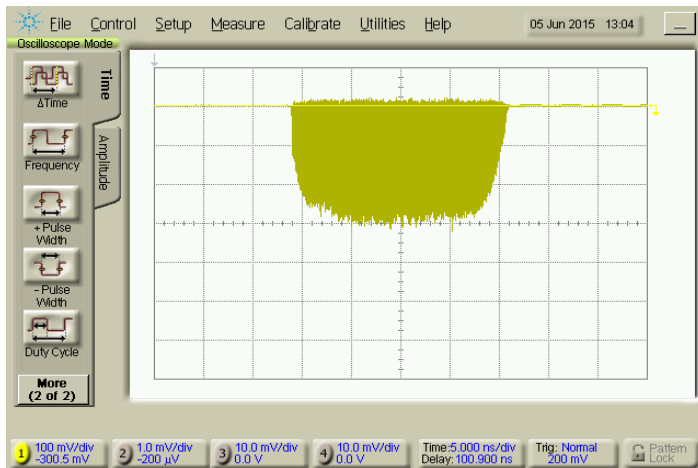

Normally OFF gating mode

The figure above shows the gating transition of a PMT in normally OFF mode with OFF-ON & ON-OFF transition in less than 5ns with a gate ON width of 30ns. The green shaded portion of the graph depicts signal.

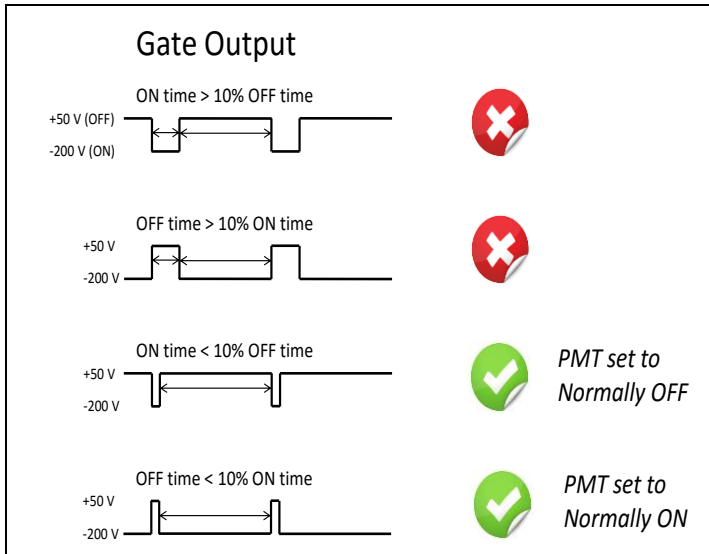

Please note that operating the PMT and gate unit with incorrect conditions for prolonged periods could result in damage to the gate unit and/or the PMT.

Gate Units

Gate Unit	Power Supply	Maximum Repetition Rate (kHz)	Rise / Fall Time (ns)	Minimum Width (ns)	Propagation delay (ns)
GM10-50B	+5 V	10	30	50	110
GM300-3N	+12 V	300	1.5	3	50
GM300-3P	+12 V	300	1.5	3	50
GM300-8U	+12 V	300	5 – 13*	8	35

*Adjustable transition time

When considering the table above, it should be noted that the limiting factor of gating performance will almost certainly be defined by the RC time constant of the PMT. The GM300-3P and 3N are complimentary units, one being designed just for short “on” windows (3N) while the other is only used for short “off” windows (3P). The GM10-50B and the GM300-8U can be used in either configuration.

For optimum gating performance, the gate unit should be connected directly to the PMT via an ‘L’ type adapter (provided with each PMT).

Configuration Diagram and setup:

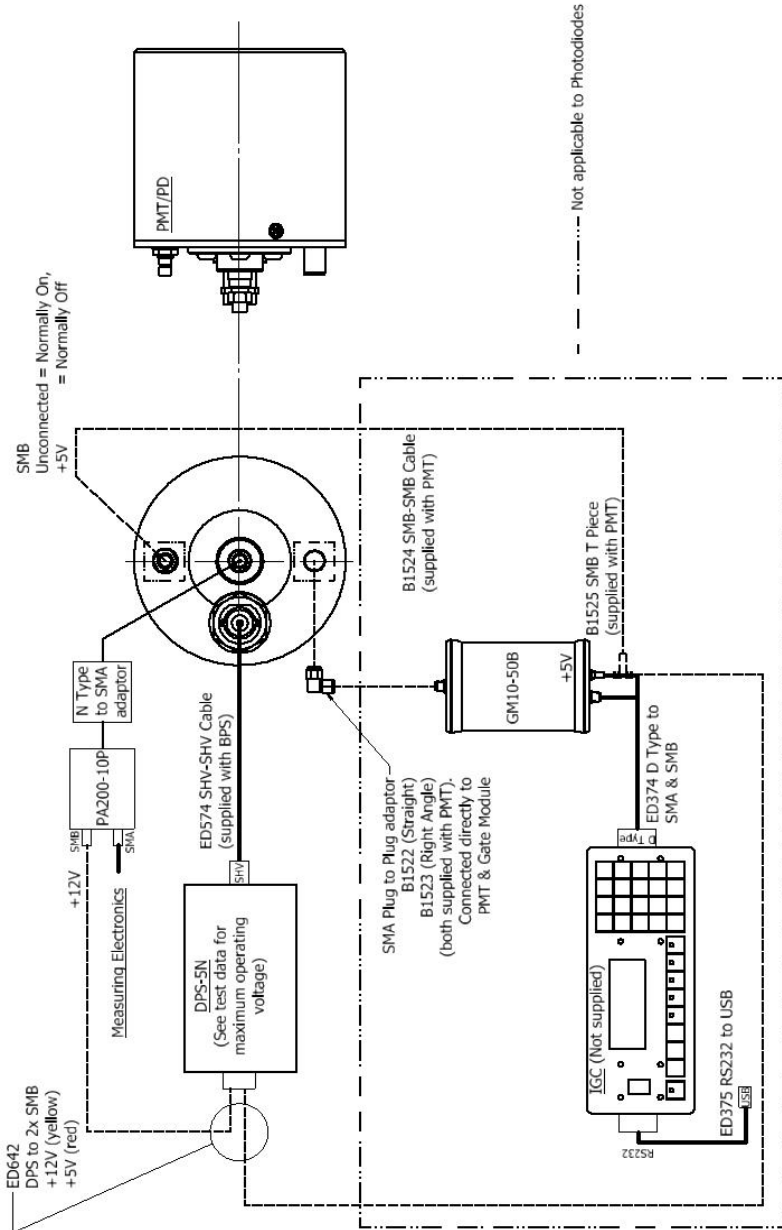

The diagram above shows a basic PMT/PD configuration setup.

Illumination Levels

In considering maximum input light levels, it is important to remember that the life of a PMT is directly dependent on illumination levels during operation. Typical operating illumination levels depend upon cathode spectral response and the number of channel plates used in the PMT.

General guide: Do not exceed 100nA average anode current. Spectral sensitivity of the photocathode in the PMT will be noticeably reduced after the extraction of $0.1\text{C}/\text{cm}^2$ of the anode charge.

Saturation characteristics:

In photon counting applications, PMTs should not be operated in excess of 50,000 to 100,000 counts per second/ cm^2 . Special high count rate PMTs can be provided that could boost this rate by a factor of 10.

In analogue applications (multi-photon mode), PMTs can produce very large currents in a very short time period. If the pulse width window is less than 1 ns, anode currents up to 1 A have been measured and will remain linear up to an integrated charge value of 1 nC up to pulse widths of 100ns.

Photodiodes are not so restricted in their dynamic range as they do not have MCPs. They should be capable of producing significantly more charge in a short analogue pulse.

Glossary of terms

Electron Gain

Electron Gain of the PMT is the ratio of output anode current to input photoelectron current generated by the photocathode.

Modal Gain

Modal gain is the mode of the number of electrons produced at the output of the MCP when a single photoelectron is incident at the input to the MCP.

Luminous Sensitivity

The responsivity of a photocathode to luminous energy in the form of a light source at a colour temperature of 2856 K. It is the ratio of photoelectric emission to incident luminous flux expressed in microamperes per lumen ($\mu\text{A/lm}$).

Photocathode

A photoelectric material, which emits electrons when irradiated with photons. Varying spectral response characteristics can be obtained by a combination of appropriate photocathode and input window material.

Quantum Efficiency

Quantum efficiency (QE) is the ratio of the number of emitted photoelectrons to the number of incident photons usually expressed as a percentage at a particular wavelength. QE can be calculated at any given wavelength from the formula:

$$QE = \frac{124 \times S(\lambda)}{\lambda}$$

Where $S(\lambda)$ is the cathode radiant sensitivity in mA/W at wavelength λ in nm.

It is important to distinguish between the responsive quantum efficiency (RQE) and the detective quantum efficiency (DQE). RQE is the fraction of input photons that give rise to primary electrons, and DQE is the fraction of input photons that give rise to discrete output events.

In MCP devices the DQE is approximately 50 - 60 % of the RQE due mainly to the effect of the open-area-ratio of the MCP. In a proximity diode, the DQE is approximately 85 % of the RQE, the difference being due only to absorption of electrons by the aluminium backing of the phosphor screen.

Radiant Sensitivity

Radiant Sensitivity is the responsivity of a photocathode to monochromatic light expressed in milliamps per watt (mA/W) at the prescribed wavelength.

Spectral Response

The Spectral Response is the variation of sensitivity with wavelength in an input window and photocathode combination. The materials used and the stoichiometry of the photocathode have a great bearing on spectral response.

Notes:

Notes:



Photek Limited
26 Castleham Road,
St Leonards on Sea,
East Sussex, TN38 9NS
United Kingdom.

Tel: +44 (0)1424 850555
Fax: +44 (0)1424 850051
sales@photek.co.uk
www.Photek.co.uk

Document	UM007
Issue	01
Date	August 2016